

SI 5ME

SI 7ME

SI 9ME

SI 11ME

SI 14ME

**Montage- und
Gebrauchsanweisung**

Deutsch

**Installation and
Operating Instructions**

English

**Instructions d'installation
et d'utilisation**

Français

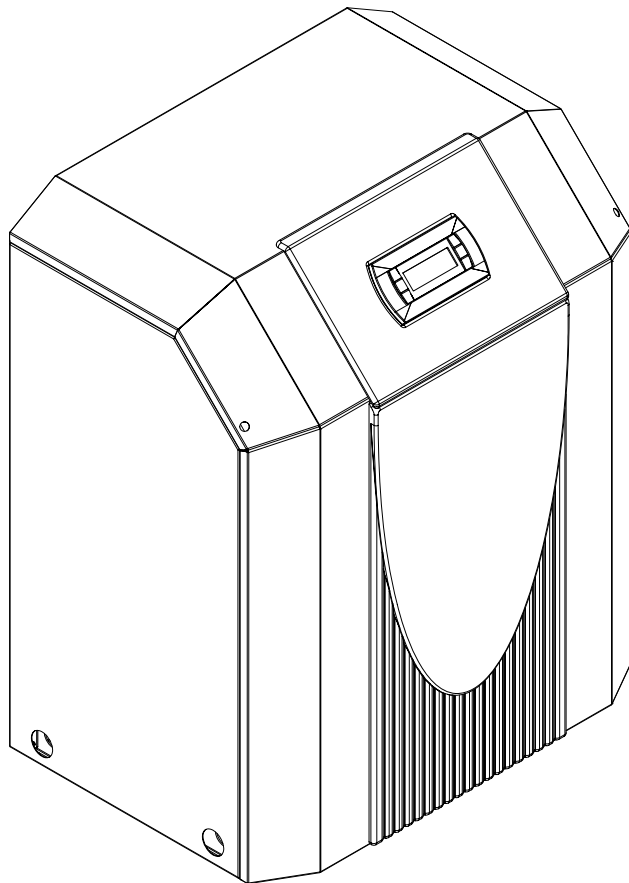

**Sole/Wasser-
Wärmepumpe für
Innenaufstellung**

**Brine-to-Water
Heat Pump for
Indoor Installation**

**Pompe à chaleur
eau glycolée-eau
pour installation
intérieure**

Table of contents

1	Please Read Immediately	E-2
1.1	Important Information.....	E-2
1.2	Legal Regulations and Directives	E-2
1.3	Energy-Efficient Use of the Heat Pump	E-2
2	Purpose of the Heat Pump	E-3
2.1	Application	E-3
2.2	Operating Principle	E-3
3	Basic Device	E-3
4	Accessories	E-4
4.1	Brine Circuit Manifold.....	E-4
5	Transport	E-4
6	Set-up	E-4
6.1	General Information	E-4
6.2	Acoustic Emissions.....	E-4
7	Installation	E-5
7.1	General Information	E-5
7.2	Heating System Connection	E-5
7.3	Heat Source Connection.....	E-5
7.4	Electrical Connection	E-5
8	Commissioning	E-6
8.1	General Information	E-6
8.2	Preparation	E-6
8.3	Start-up Procedure	E-6
9	Maintenance and Cleaning	E-7
9.1	Maintenance	E-7
9.2	Cleaning the Heating System	E-7
9.3	Cleaning the Heat Source System.....	E-7
10	Faults / Trouble-Shooting	E-7
11	Decommissioning / Disposal	E-7
12	Device Information	E-8
	Anhang / Appendix / Annexes	A-I

1 Please Read Immediately

1.1 Important Information

ATTENTION!

The heat pump is not secured to the wooden pallet.

ATTENTION!

The heat pump must not be tilted more than 45° (in any direction).

ATTENTION!

Do not use the holes in the panel assemblies for lifting the device!

ATTENTION!

Flush the heating system prior to connecting the heat pump.

ATTENTION!

The supplied dirt trap must be inserted in the heat source inlet of the heat pump to protect the evaporator against the ingress of impurities.

ATTENTION!

The brine solution must contain at least a 25 % concentration of a monoethylene glycol or propylene glycol-based antifreeze, which must be mixed before filling.

ATTENTION!

The heat pump must be started up in accordance with the installation and operating instructions of the heat pump controller.

ATTENTION!

We recommend the installation of a suitable corrosion protection system to prevent the formation of deposits (e.g. rust) in the condenser of the heat pump.

ATTENTION!

Any work on the heat pump may only be performed by authorised and qualified after-sales service technicians.

ATTENTION!

Disconnect all electrical circuits from the power source prior to opening the device.

1.2 Legal Regulations and Directives

This heat pump conforms to all relevant DIN/VDE regulations and EU directives. Refer to the EC Declaration of Conformity in the appendix for details.

The heat pump must be connected to the power supply in compliance with all relevant VDE, EN and IEC standards. Any further connection requirements stipulated by local utility companies must also be observed.

The heat pump is to be connected to the heat source system and the heating system in accordance with all applicable regulations.

Persons, especially children, who are not capable of operating the device safely due to their physical, sensory or mental abilities or their inexperience or lack of knowledge, must not operate this device without supervision or instruction by the person in charge.

Children must be supervised to ensure that they do not play with the device.

1.3 Energy-Efficient Use of the Heat Pump

By operating this heat pump you are helping to protect our environment. Both the heating system and the heat source must be properly designed and dimensioned to ensure efficient operation. It is particularly important to keep water flow temperatures as low as possible. All connected energy consumers should therefore be suitable for low flow temperatures. Raising the heating water temperature by 1 K corresponds to an increase in energy consumption of approx.

2.5 %. Low-temperature heating systems with flow temperatures between 30 °C and 50 °C are particularly well-suited for energy-efficient operation.

2 Purpose of the Heat Pump

2.1 Application

The brine-to-water heat pump is designed for use in existing or newly built heating systems. Brine is used as the heat carrier in the heat source system. Borehole heat exchangers, ground heat collectors or similar systems can be used as the heat source.

2.2 Operating Principle

The heat generated by the sun, wind and rain is stored in the ground. This heat stored in the ground is collected at a low temperature by the brine circulating in the ground collector, ground coil or similar device. A circulating pump then conveys the "heated" brine to the evaporator of the heat pump. There the heat is given off to the refrigerant in the refrigerating cycle. This cools the brine so that it can once again absorb thermal energy in the brine circuit.

The refrigerant is drawn in by the electrically driven compressor, compressed and "pumped" to a higher temperature level. The electrical power needed to run the compressor is not lost in this process. Most of it is absorbed by the refrigerant.

Subsequently, the refrigerant is passed through the condenser where it transfers its heat energy to the heating water. Depending on the set operating point (thermostat setting), the heating water is thus heated up to a max. of 60 °C.

3 Basic Device

The basic device consists of a ready-to-use heat pump for indoor installation, complete with sheet metal casing, control panel and integrated controller. The refrigerating cycle contains the refrigerant R407C. R407C refrigerant is CFC-free, non-ozone depleting and non-combustible.

All components required for the operation of the heat pump are located on the control panel. An external wall temperature sensor including fixing accessories and a dirt trap are supplied with the heat pump. The power feed for the load current and the control current must be installed by the customer.

The supply lead of the brine circulating pump (to be provided by the customer) must be connected to the control panel. If required, the supply lead of the brine pump is equipped with a motor protection device.

The customer must provide both the collector and the brine circuit manifold.



- 1) Liquifier
- 2) Control panel
- 3) Evaporator
- 4) Compressor

4 Accessories

4.1 Brine Circuit Manifold

The brine circuit manifold merges the individual collector loops of the heat source system into a single main pipe which is connected to the heat pump. Integrated ball valves allow the individual brine circuits to be shut off for de-aeration purposes.

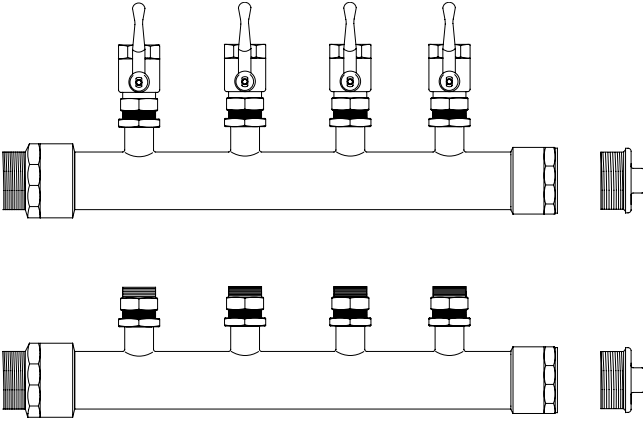

5 Transport

A lift truck is suited for transporting the unit on a level surface. Carrying straps may be used if the heat pump needs to be transported on an uneven surface or carried up or down stairs. These straps can be passed directly underneath the wooden pallet.

⚠ ATTENTION!

The heat pump is not secured to the wooden pallet.

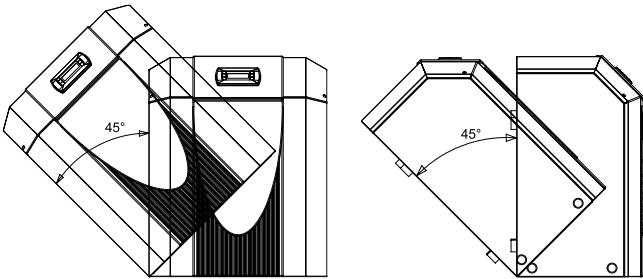

⚠ ATTENTION!

The heat pump must not be tilted more than 45° (in any direction).

Use the holes provided in the sides of the frame to lift the unit without the pallet. The side panel assemblies must be removed for this purpose. Any commercially available length of pipe can be used as a carrying aid.

⚠ ATTENTION!

Do not use the holes in the panel assemblies for lifting the device!

6 Set-up

6.1 General Information

The unit may only be installed indoors in rooms with low humidity on a level, smooth and horizontal surface. The entire base of the frame should lie directly on the floor to ensure a good soundproof seal. If this is not the case, additional sound insulation measures may be necessary.

The heat pump must be installed so that maintenance work can be carried out without hindrance. This can be ensured by maintaining a clearance of approx. 1 m in front of and on each side of the heat pump.

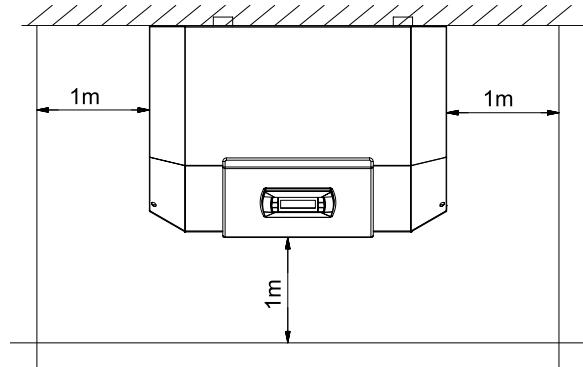

6.2 Acoustic Emissions

The heat pump operates silently due to efficient sound insulation. To prevent noise transmission to the foundation, a suitable, sound dampening rubber mat should be placed underneath the base frame of the heat pump.

To prevent any sound from being transmitted to the heating system, we recommend connecting the heat pump to the heating system by means of hose sections.

7 Installation

7.1 General Information

The following connections need to be established on the heat pump:

- Flow and return flow of the brine system
- Flow and return flow of the heating system
- Power supply

7.2 Heating System Connection

⚠ ATTENTION!

Flush the heating system prior to connecting the heat pump.

Before connecting the heating water system to the heat pump, the heating system must be flushed to remove any impurities, residue from sealants, etc. Any accumulation of deposits in the liquifier could cause the heat pump to completely break down.

Once the heating system has been installed, it must be filled, de-aerated and pressure-tested.

The sensors which are delivered already connected and loosely placed in the switch box must be mounted and insulated according to the block diagram.

Minimum heating water flow rate

The minimum heating water flow rate through the heat pump must be assured in all operating states of the heating system. This can be accomplished, for example, by installing either a manifold without differential pressure or an overflow valve. The procedure for adjusting an overflow valve is described in the Chapter Start-Up.

Antifreeze protection for installation locations prone to frost

The antifreeze function of the heat pump controller is active whenever the controller and the heat circulating pumps are ready for operation. If the heat pump is taken out of service or in the event of a power failure, the system has to be drained. The heating circuit should be operated with a suitable antifreeze if heat pump systems are implemented in buildings where a power failure can not be detected (holiday home).

7.3 Heat Source Connection

The following procedure must be observed when connecting the heat source:

Connect the brine pipe to the heat pump flow and return. The hydraulic plumbing diagram must be adhered to.

⚠ ATTENTION!

The supplied dirt trap must be inserted in the heat source inlet of the heat pump to protect the evaporator against the ingress of impurities.

In addition, a micro bubble air separator must be installed in the heat source system.

The brine liquid must be produced prior to charging the system. The liquid must have an antifreeze concentration of at least 25 % to ensure frost protection down to -14 °C.

Only monoethylene glycol or propylene glycol-based antifreeze may be used.

The heat source system must be de-aerated and checked for leaks.

⚠ ATTENTION!

The brine solution must contain at least a 25 % concentration of a monoethylene glycol or propylene glycol-based antifreeze, which must be mixed before filling.

7.4 Electrical Connection

The following electrical connections must be established on the heat pump:

- Connection of the control line to the control panel of the heat pump via terminal X1: L/N/PE.
- Connection of the mains cable to the control panel of the heat pump via terminal X6: L/N//PE.
- Connection of the brine circulating pump (to be provided by the customer) to the control panel of the heat pump via terminal X1: PE and pump contactor K5: 2/4. As an option, the brine pump can also be directly connected (see terminal connection plan).

All electrical components required for the operation of the heat pump are located on the control panel.

For detailed instructions concerning the connection and functioning of the heat pump controller (e.g. external wall sensor included in the scope of supply) refer to the operating manual supplied with the controller.

An disconnecting device with a contact gap of at least 3 mm (e.g. utility blocking contactor or power contactor) as well as a 1-pole circuit breaker have to be provided by the customer. The required conductor cross section is to be selected according to the power consumption of the heat pump, the technical connection requirements of the respective utility company as well as all applicable regulations. Details on the power consumption of the heat pump are listed on both the product information sheet and the type plate. The connection terminals are designed for a max. conductor cross section of 10 mm².

8 Commissioning

8.1 General Information

To ensure that start-up is performed correctly, it should only be carried out by an after-sales service technician authorised by the manufacturer. This may be a condition for extending the guarantee (see Warranty).

8.2 Preparation

The following items need to be checked prior to start-up:

- The heat pump must be fully connected, as described in Chapter 7.
- The heat source system and the heating circuit must have been filled and checked.
- The dirt trap must be inserted in the brine inlet of the heat pump.
- All valves that could impair proper flow in the brine and heating circuits must be open.
- The heat pump controller must be adapted to the heating system in accordance with the controller's operating instructions.

8.3 Start-up Procedure

The heat pump is started up via the heat pump controller.

⚠ ATTENTION!

The heat pump must be started up in accordance with the installation and operating instructions of the heat pump controller.

If an overflow valve is fitted to assure the minimum heating water flow rate, the valve must be set in accordance with the requirements of the respective heating system. Incorrect adjustment can lead to faulty operation and increased energy consumption. We recommend carrying out the following procedure to correctly adjust the overflow valve:

Close all of the heating circuits that may also be closed during operation (depending on the type of heat pump usage) so that the most unfavourable operating state - with respect to the water flow rate - is achieved. This normally means the heating circuits of the rooms on the south and west sides of the building. At least one heating circuit must remain open (e.g. bathroom).

The overflow valve should be opened far enough to produce the maximum temperature spread between the heating flow and return flow listed in the table below for the current heat source temperature. The temperature spread should be measured as close as possible to the heat pump. The heating element of mono energy systems should be disconnected.

Heat source temperature		Max. temperature spread between heating flow and return flow
From	To	
-5° C	0° C	10 K
1° C	5° C	11 K
6° C	9° C	12 K
10° C	14° C	13 K
15° C	20° C	14 K
21° C	25° C	15 K

Any faults occurring during operation are displayed on the heat pump controller and can be corrected as described in the operating manual of the heat pump controller.

9 Maintenance and Cleaning

9.1 Maintenance

The heat pump is maintenance-free. To prevent faults due to sediment in the heat exchangers, care must be taken to ensure that no impurities can enter either the heat source system or the heating system. In the event that operating malfunctions due to contamination occur nevertheless, the system should be cleaned as described below.

9.2 Cleaning the Heating System

The ingress of oxygen into the heating water circuit may result in the formation of oxidation products (rust), particularly if steel components are used. This oxygen enters the heating system via the valves, the circulating pumps and/or plastic pipes. It is therefore essential - in particular with respect to the piping of under-floor heating systems - that only diffusion-proof materials are used.

⚠ ATTENTION!

We recommend the installation of a suitable corrosion protection system to prevent the formation of deposits (e.g. rust) in the condenser of the heat pump.

Residue from lubricants and sealants may also contaminate the heating water.

In the case of severe contamination leading to a reduction in the performance of the liquifier in the heat pump, the system must be cleaned by a heating technician.

According to today's state of knowledge, we recommend using a 5 % phosphoric acid solution for cleaning purposes. However, if cleaning needs to be performed more frequently, a 5 % formic acid solution should be used.

In either case, the cleaning fluid should be at room temperature. We recommend flushing the heat exchanger in the direction opposite to the normal flow direction.

To prevent acidic cleaning agents from entering the heating system circuit, we recommend connecting the flushing device directly to the flow and return flow of the liquifier. It is important that the system be thoroughly flushed using appropriate neutralising agents to prevent any damage from being caused by cleaning agent residue remaining in the system.

Acids must be used with great care and all relevant regulations of the employers' liability insurance associations must be adhered to.

If in doubt, contact the manufacturer of the chemicals!

9.3 Cleaning the Heat Source System

⚠ ATTENTION!

The supplied dirt trap must be inserted in the heat source inlet of the heat pump to protect the evaporator against the ingress of impurities.

Clean the dirt trap's filter screen one day after start-up and subsequently in weekly intervals. If no more signs of contamination are evident, the filter can be removed to reduce pressure drops.

10 Faults / Trouble-Shooting

This heat pump is a quality product and is designed for trouble-free operation. In the event that a fault should occur, it will be indicated on the heat pump manager display. Simply consult the Faults and Trouble-Shooting page in the operating instructions of the heat pump controller.

If you cannot correct the fault yourself, please contact your after-sales service technician.

⚠ ATTENTION!

Any work on the heat pump may only be performed by authorised and qualified after-sales service technicians.

⚠ ATTENTION!

Disconnect all electrical circuits from the power source prior to opening the device.

11 Decommissioning / Disposal

Before removing the heat pump, disconnect it from the power source and close all valves. Observe all environmentally-relevant requirements regarding the recovery, recycling and disposal of materials and components in accordance with all applicable standards. Particular attention should be paid to the proper disposal of refrigerants and refrigeration oils.

12 Device Information

1 Type and order code	SI 5ME	SI 7ME	SI 9ME	SI 11ME	SI 14ME
2 Design					
2.1 Degree of protection according to EN 60 529	IP 20	IP 20	IP 20	IP 20	IP 20
2.2 Installation Location	Indoors	Indoors	Indoors	Indoors	Indoors
3 Performance data					
3.1 Operating temperature limits:					
Heating water flow °C	Up to 58	Up to 58	Up to 58	Up to 58	Up to 58
Brine (heat source) °C	-5 to +25	-5 to +25	-5 to +25	-5 to +25	-5 to +25
Antifreeze	Mono-ethylene glycol	Mono-ethylene glycol	Mono-ethylene glycol	Mono-ethylene glycol	Mono-ethylene glycol
Minimum brine concentration (-13 °C freezing temperature)	25%	25%	25%	25%	25%
3.2 Temperature spread of heating water (flow/return flow) at B0 / W35 K	9.6 5.0	9.1 5.0	10.5 5.0	9.5 5.0	9.6 5.0
3.3 Heat output / COP at B-5 / W55 ¹ kW / ---	4.0 / 2.0	5.4 / 2.1	7.6 / 2.1	9.4 / 2.0	12.3 / 2.1
at B0 / W45 ¹ kW / ---	4.6 / 2.7	5.7 / 2.7	8.5 / 2.8	10.0 / 2.9	14.7 / 2.9
at B0 / W50 ¹ kW / ---	4.8 / 2.7	6.2 / 2.7	8.8 / 2.7	10.5 / 2.6	14.2 / 2.8
at B0 / W35 ¹ kW / ---	5.0 / 4.0 4.9 / 3.8	6.5 / 3.9 6.3 / 3.7	9.3 / 4.0 8.9 / 3.8	11.0 / 4.0 10.8 / 3.9	15.0 / 4.1 14.8 / 3.9
3.4 Sound power level dB(A)	54	55	56	56	56
3.5 Heating water flow with an internal pressure differential of m ³ /h / Pa	0.45 / 1900 0.85 / 6500	0.6 / 3300 1.1 / 10000	0.75 / 2300 1.5 / 9200	1.0 / 4100 1.9 / 15000	1.3 / 4800 2.6 / 19200
3.6 Brine throughput with an internal pressure differential (heat source) of m ³ /h / Pa	1.2 / 16000 1.2 / 16000	1.7 / 29500 1.7 / 29500	2.3 / 25000 2.0 / 20000	3.0 / 24000 2.5 / 18000	3.5 / 20000 3.5 / 20000
3.7 Refrigerant; total filling weight type / kg	R407C / 1.2	R407C / 1.4	R407C / 1.7	R407C / 1.9	R407C / 2.2
4 Dimensions, connections and weight					
4.1 Device dimensions without connections ² H x W x L mm	805 x 650 x 462	805 x 650 x 462	805 x 650 x 462	805 x 650 x 462	805 x 650 x 462
4.2 Device connections to heating system Inch	G 1¼" external	G 1¼" external	G 1¼" external	G 1¼" external	G 1¼" external
4.3 Device connections to heat source Inch	G 1¼" external	G 1¼" external	G 1¼" external	G 1¼" external	G 1¼" external
4.4 Weight of the transportable unit(s) incl. packing kg	109	111	118	122	130
5 Electrical Connection					
5.1 Nominal voltage; fuse protection V / A	230 / 16	230 / 16	230 / 20	230 / 25	230 / 32
5.2 Nominal power consumption ¹ B0 W35 kW	1.26 1.30	1.68 1.70	2.30 2.35	2.75 2.77	3.70 3.76
5.3 Starting current with soft starter A	24	26	38	38	50
5.4 Nominal current B0 W35 / cos φ A / ---	6.8 / 0.8 7.1 / 0.8	9.1 / 0.8 9.3 / 0.8	12.6 / 0.8 12.9 / 0.8	15.0 / 0.8 15.3 / 0.8	19.7 / 0.8 20.0 / 0.8
6 Complies with the European safety regulations	3	3	3	3	3
7 Additional model features					
7.1 Water in device protected against freezing ⁴	No	No	No	No	No
7.2 Performance levels	1	1	1	1	1
7.3 Controller internal/external	Internal	Internal	Internal	Internal	Internal

1. This data indicates the size and capacity of the system. For an analysis of the economic and energy efficiency of the system, both the bivalence point and the regulation should also be taken into consideration. The specified values, e.g. B10 / W55, have the following meaning: Heat source temperature 10 °C and heating water flow temperature 55 °C.

2. Note that additional space is required for pipe connections, operation and maintenance.

3. See CE declaration of conformity

4. The heat circulating pump and the heat pump controller must always be ready for operation.

Anhang / Appendix / Annexes

1	Maßbilder / Dimension Drawings / Schémas cotés	A-II
1.1	Maßbild / Dimension Drawing / Schéma coté.....	A-II
2	Diagramme / Diagrams / Diagrammes	A-III
2.1	Kennlinien / Characteristic Curves / Courbes caractéristiques SI 5ME.....	A-III
2.2	Kennlinien / Characteristic Curves / Courbes caractéristiques SI 7ME.....	A-IV
2.3	Kennlinien / Characteristic Curves / Courbes caractéristiques SI 9ME.....	A-V
2.4	Kennlinien / Characteristic Curves / Courbes caractéristiques SI 11ME.....	A-VI
2.5	Kennlinien / Characteristic Curves / Courbes caractéristiques SI 14ME.....	A-VII
3	Stromlaufpläne / Circuit Diagrams / Schémas électriques	A-VIII
3.1	Steuerung / Control / Commande.....	A-VIII
3.2	Last / Load / Charge.....	A-IX
3.3	Klemmenanschlussplan / Terminal Connection Plan / Schéma de connexion des bornes.....	A-X
3.4	Legende / Legend / Légende.....	A-XI
4	Hydraulisches Prinzipschema / Hydraulic Plumbing Diagram / Schéma hydraulique	A-XII
4.1	Darstellung / Schematic View / Représentation.....	A-XII
4.2	Legende / Legend / Légende.....	A-XIII
5	Konformitätserklärung / Declaration of Conformity / Déclaration de conformité	A-XIV

1 Maßbilder / Dimension Drawings / Schémas cotés

1.1 Maßbild / Dimension Drawing / Schéma coté

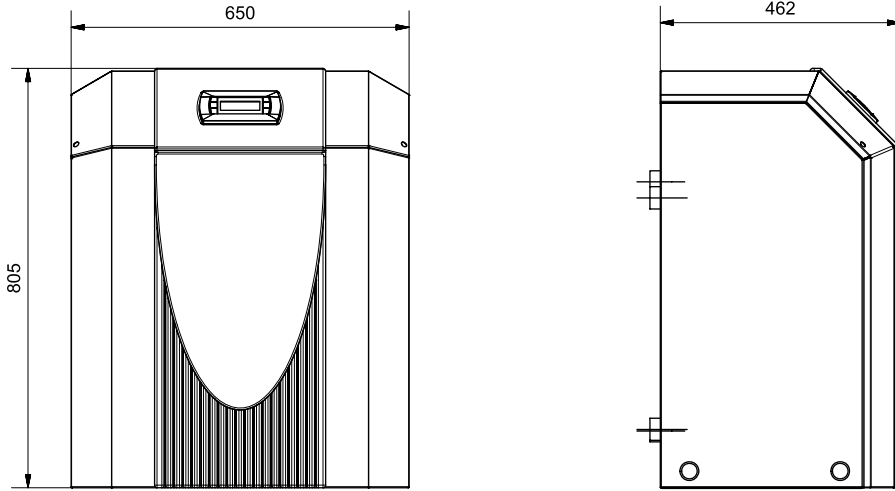

ca. / approx. / env. 20

(1 : 20)

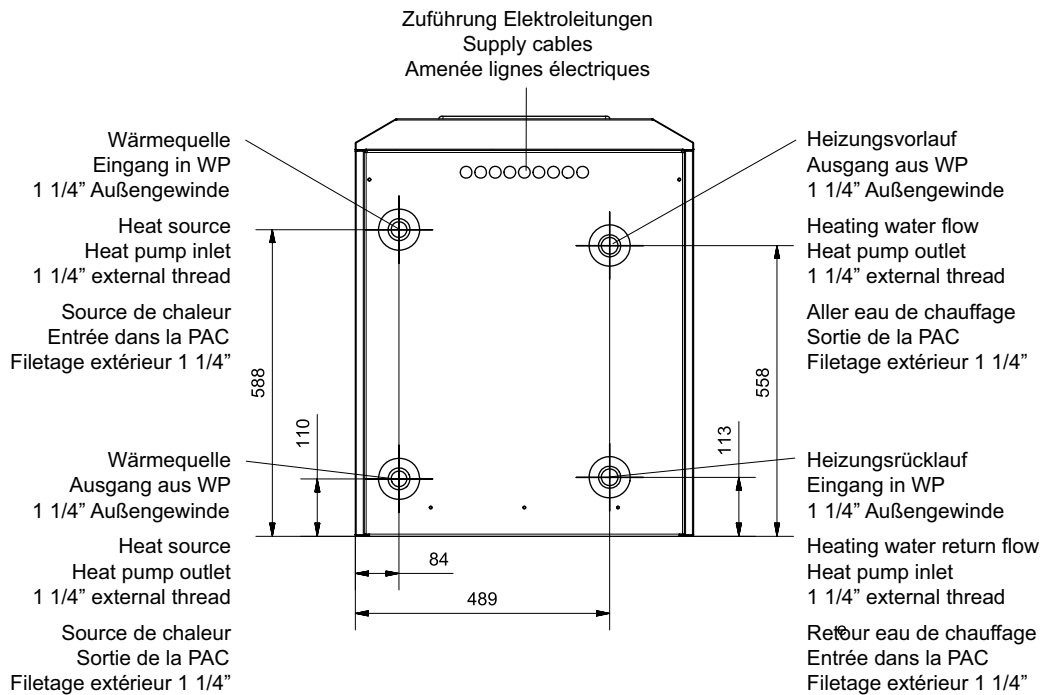
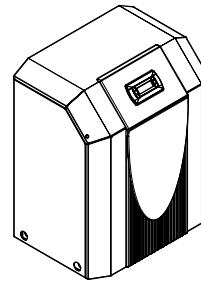
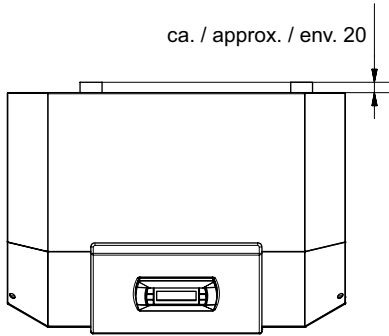

2 Diagramme / Diagrams / Diagrammes

2.1 Kennlinien / Characteristic Curves / Courbes caractéristiques SI 5ME

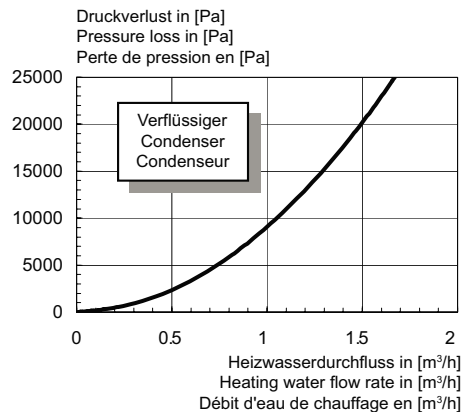
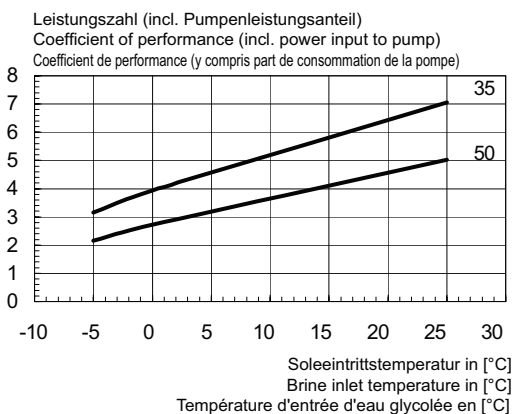
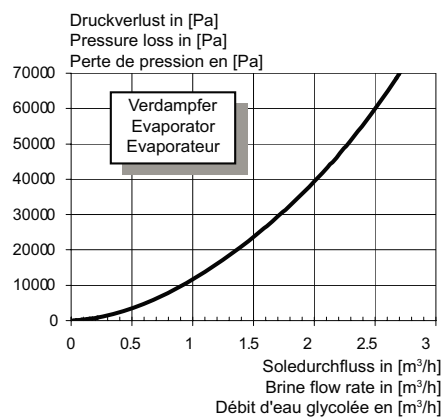
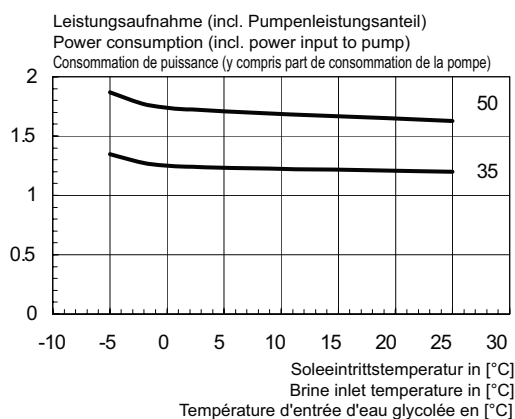
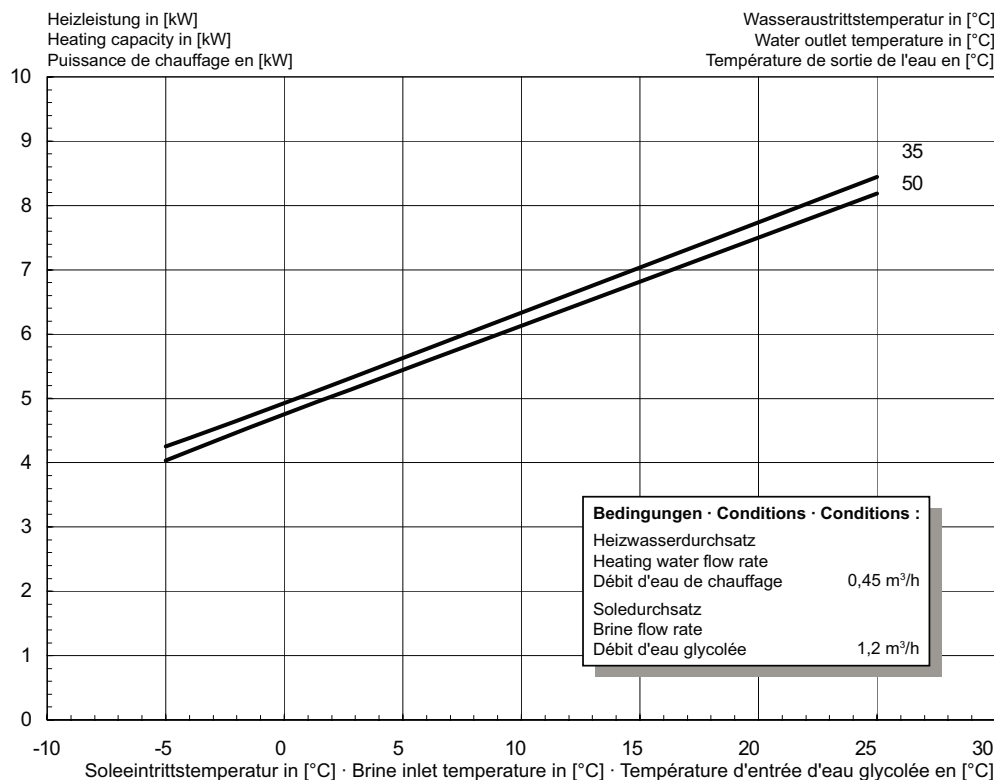

2.2 Kennlinien / Characteristic Curves / Courbes caractéristiques SI 7ME

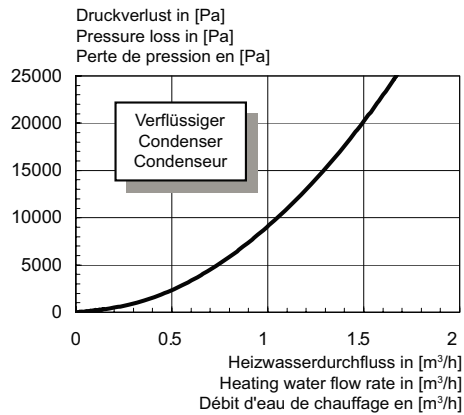
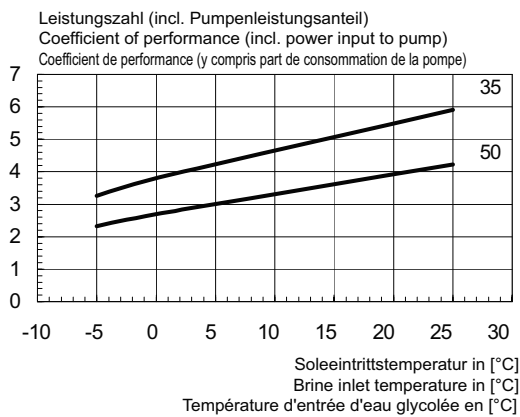
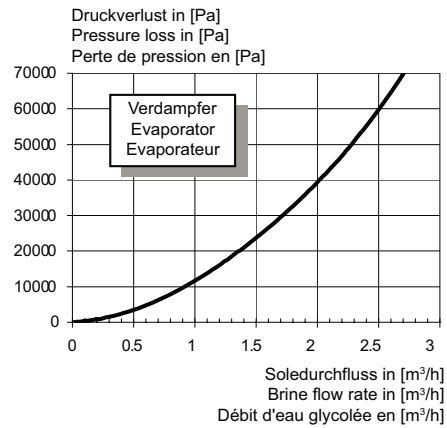
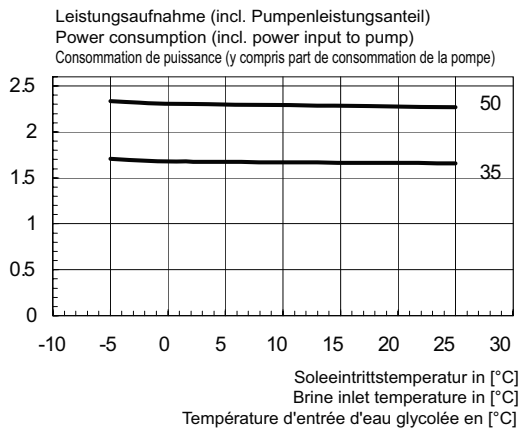
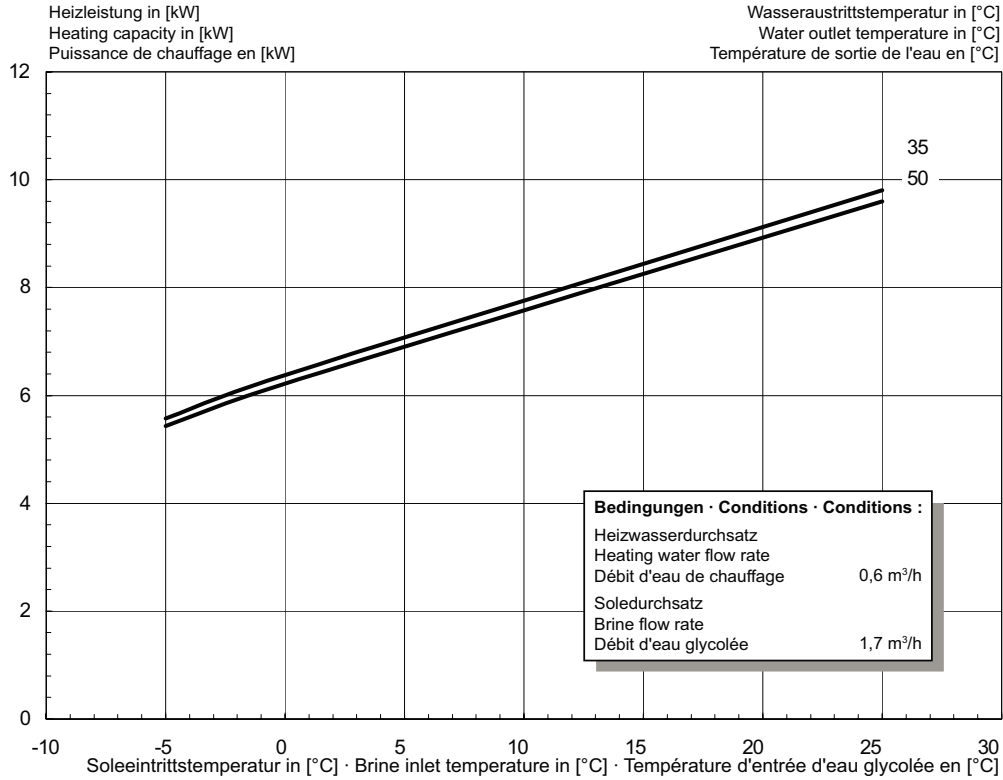

Anhang · Appendix · Annexes

2.3 Kennlinien / Characteristic Curves / Courbes caractéristiques SI 9ME

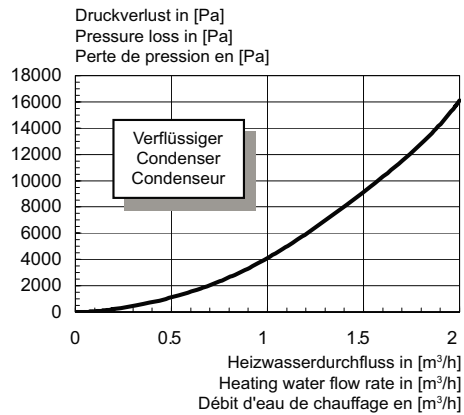
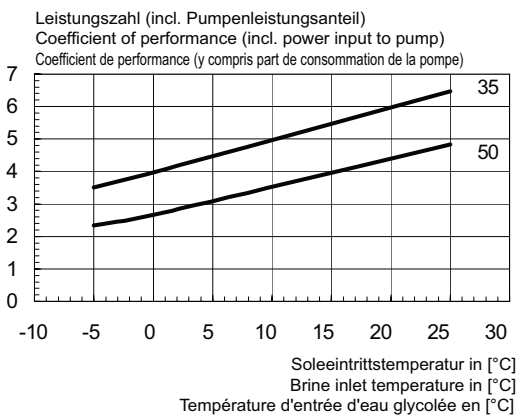
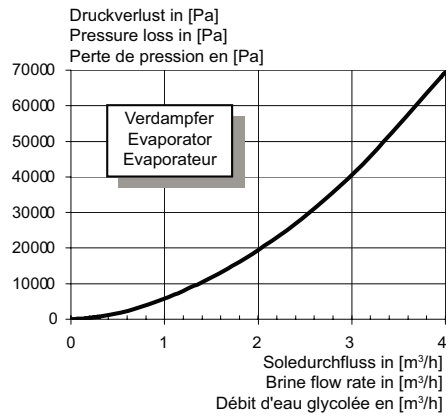
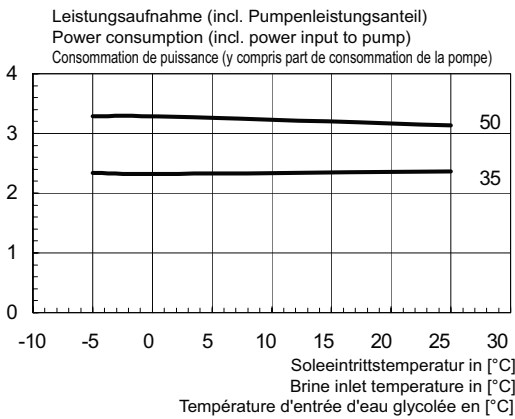
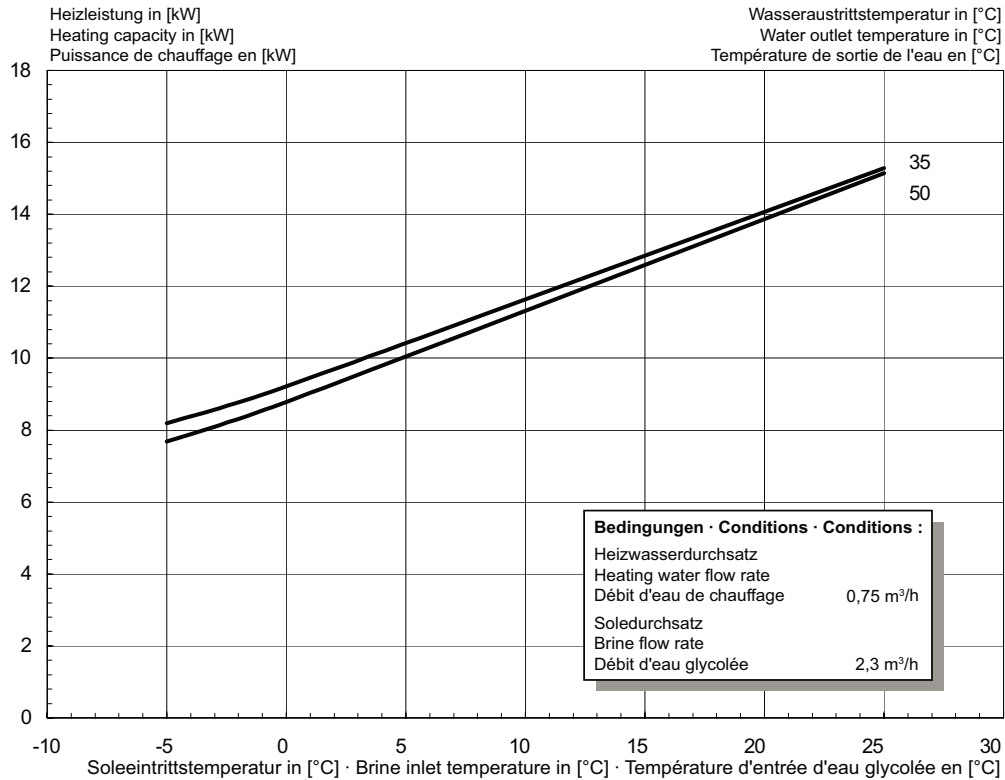

2.4 Kennlinien / Characteristic Curves / Courbes caractéristiques SI 11ME

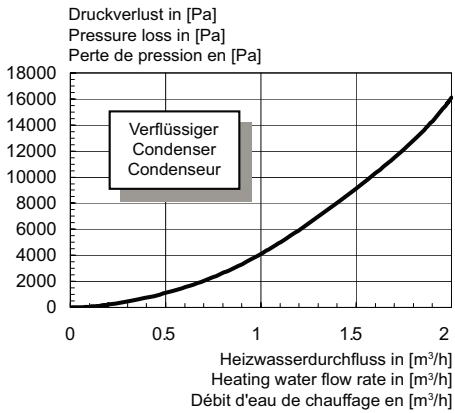
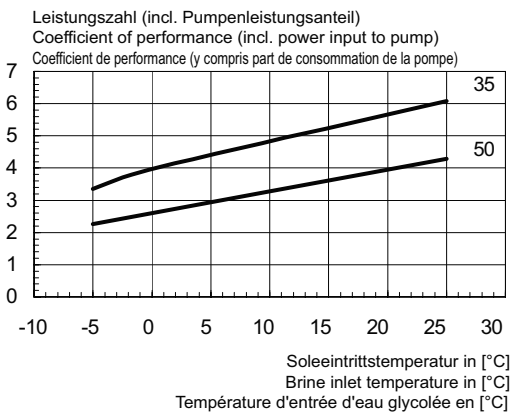
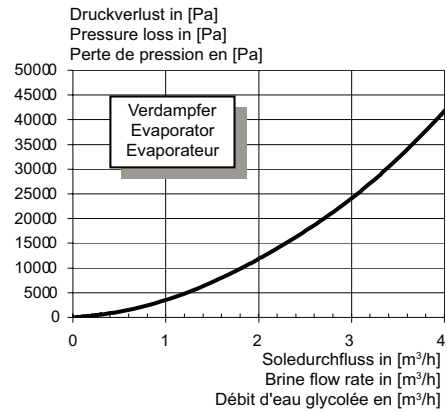
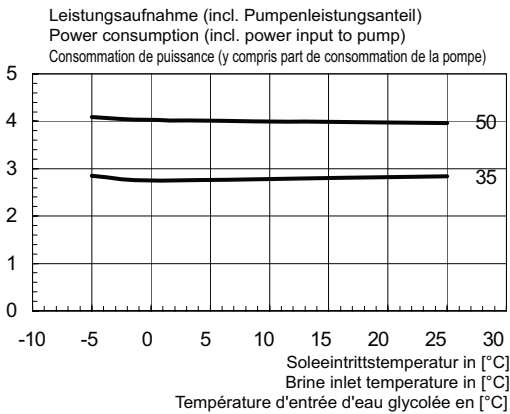
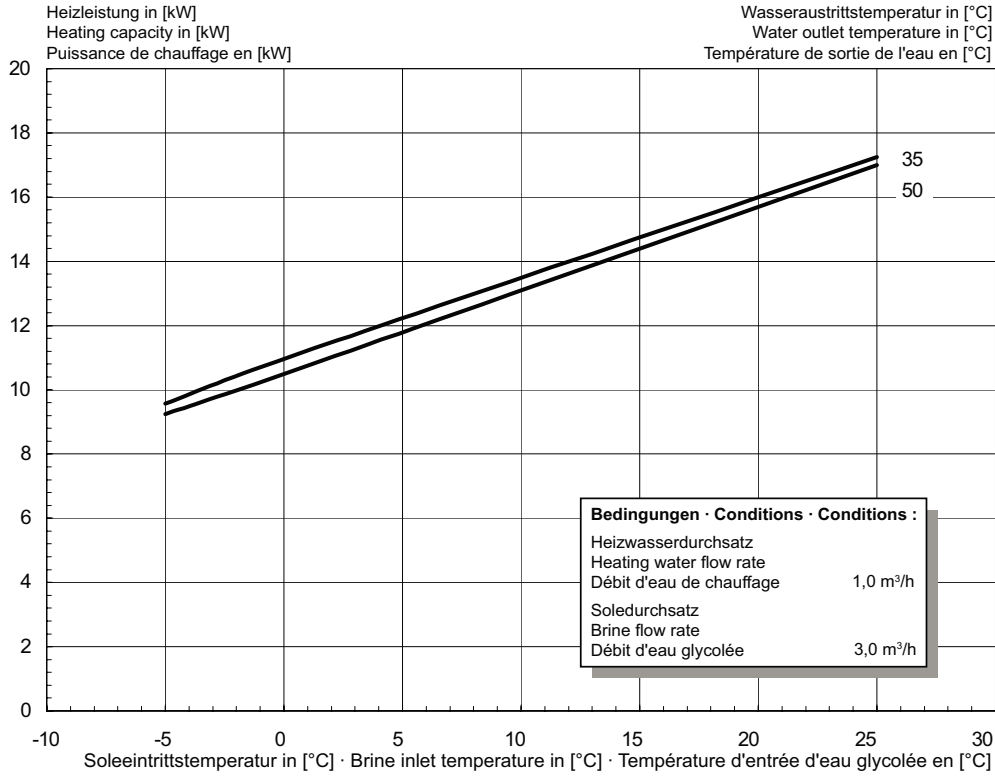

2.5 Kennlinien / Characteristic Curves / Courbes caractéristiques SI 14ME

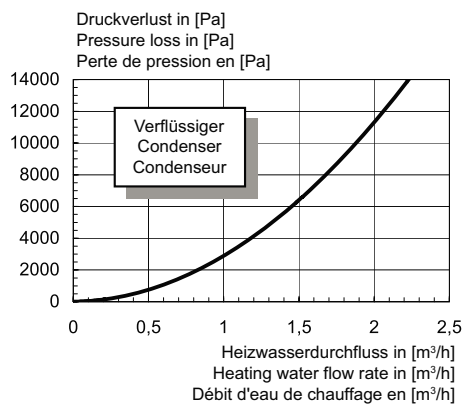
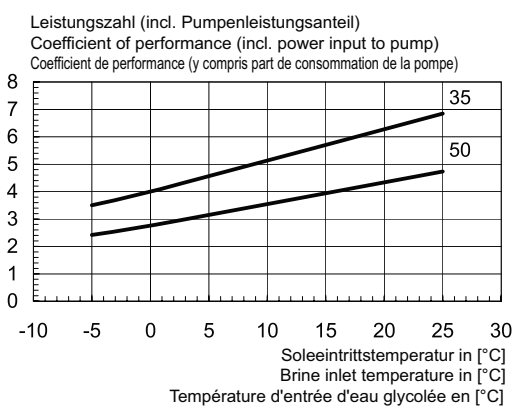
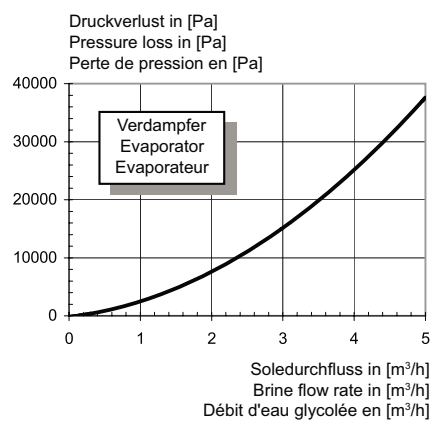
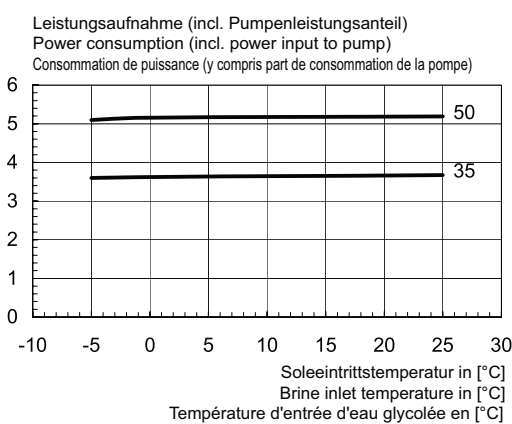
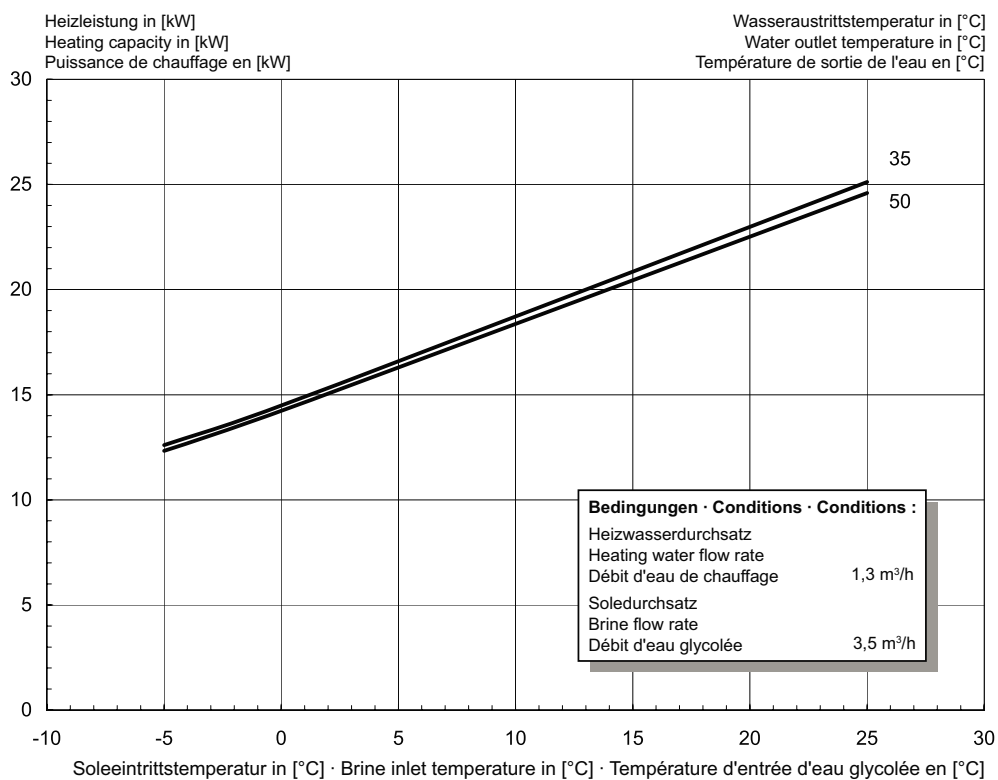

3 Stromlaufpläne / Circuit Diagrams / Schémas électriques

3.1 Steuerung / Control / Commande

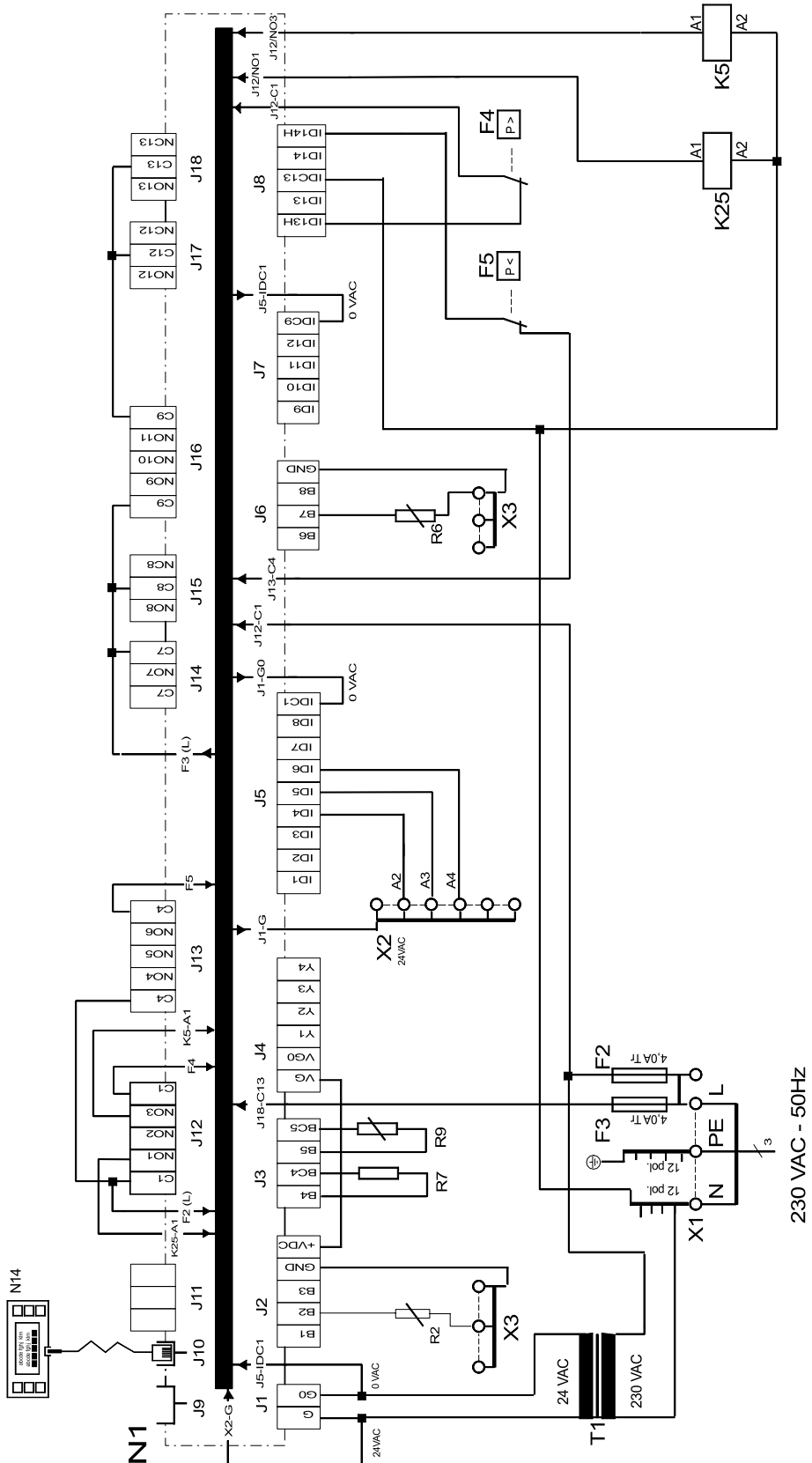

Anhang · Appendix · Annexes

3.2 Last / Load / Charge

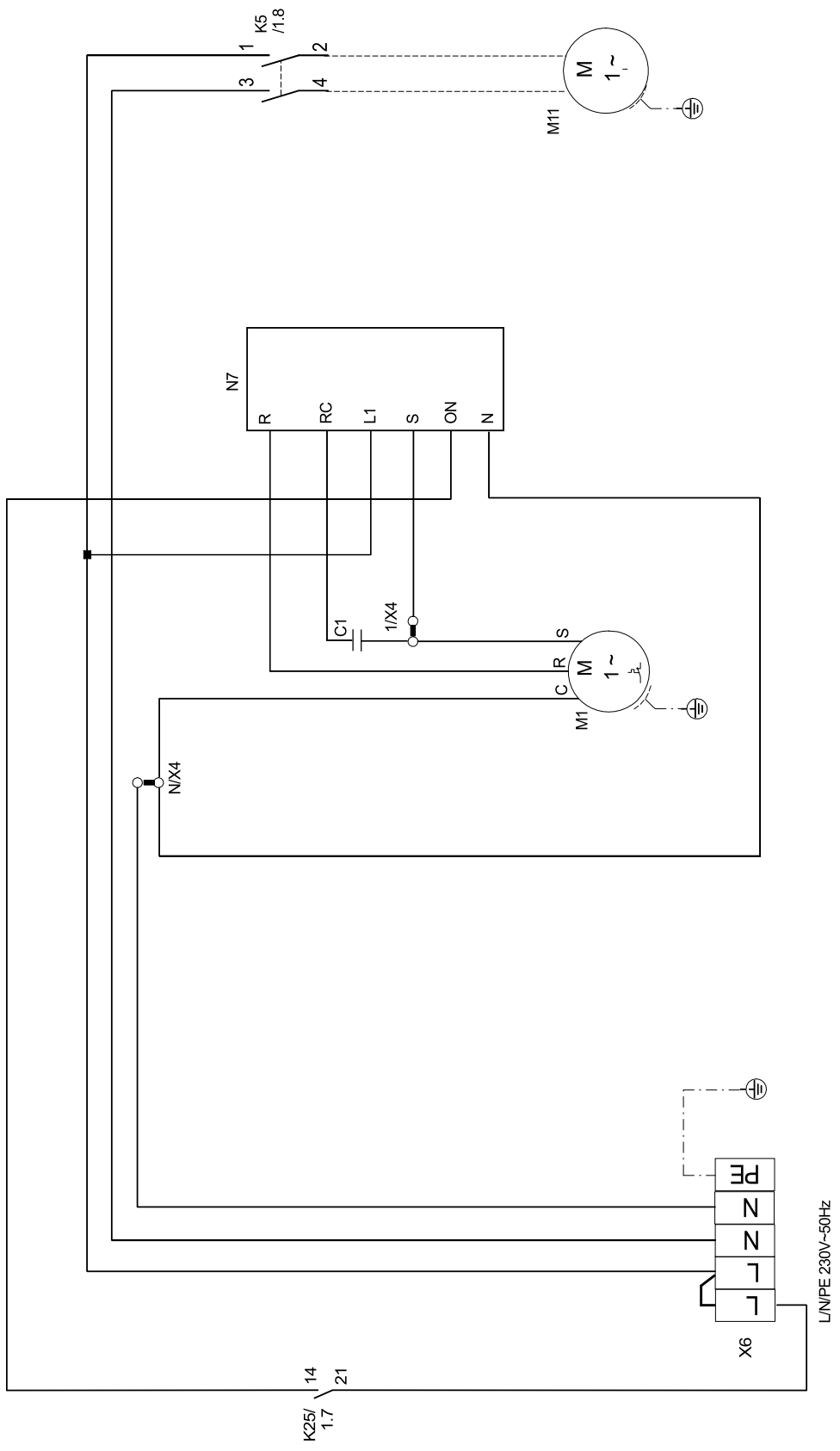

3.3 Klemmenanschlussplan / Terminal Connection Plan / Schéma de connexion des bornes

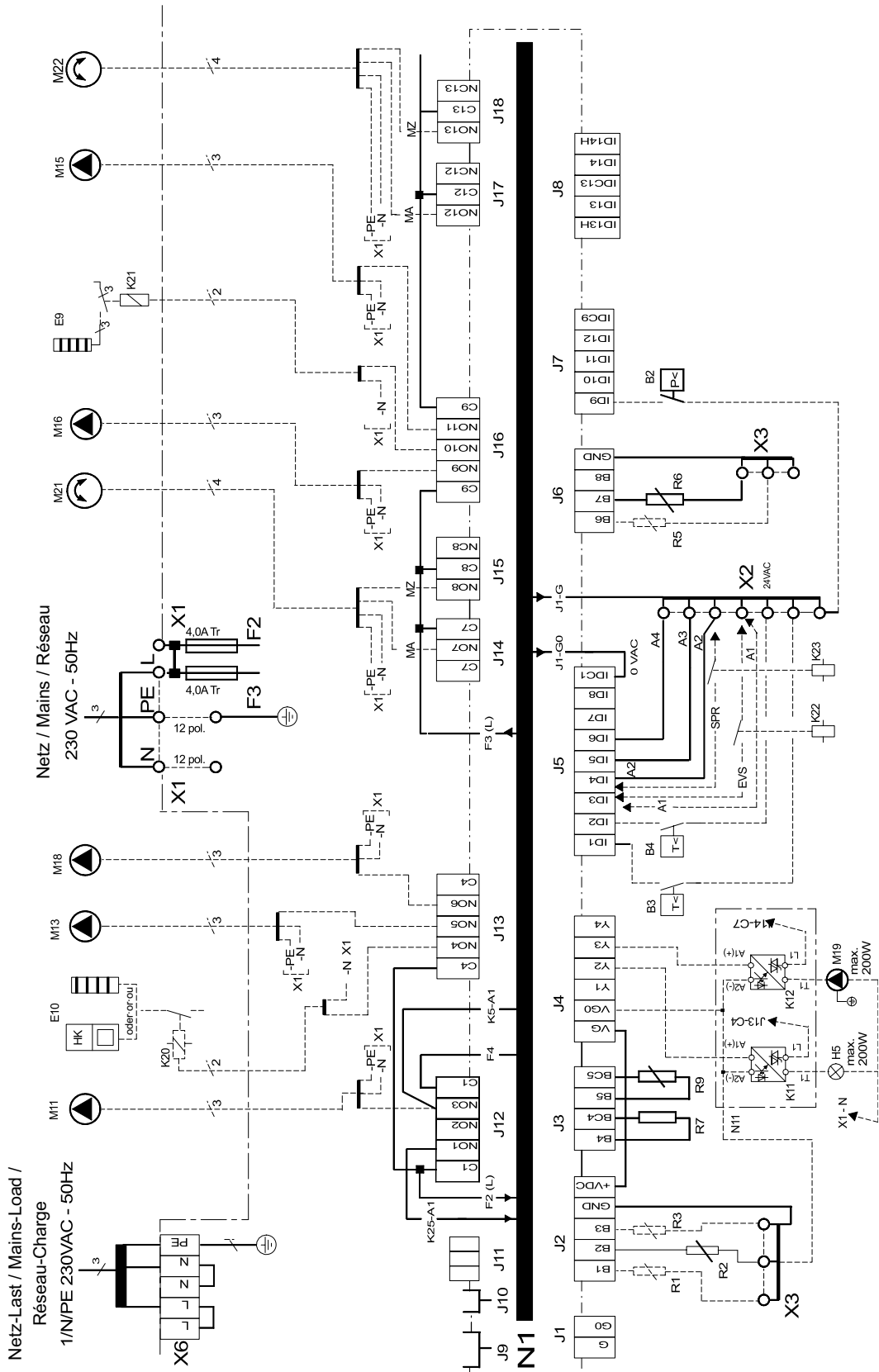

Anhang · Appendix · Annexes

3.4 Legende / Legend / Légende

A1	Drahtbrücke, muss eingelegt werden, wenn kein Sperrschütz vorhanden ist	Wire jumper, must be inserted if no blocking contactor is fitted	Le cavalier à fil doit être inséré en absence de disjoncteur de blocage du fournisseur d'énergie.
A2	Drahtbrücke, muss bei Verwendung des 2ten Sperreinganges entfernt werden	Wire jumper, must be removed if the 2nd disable contactor is used	Cavalier à fil à retirer si la 2e entrée de coupure est utilisée
A3	Drahtbrücke, muss bei Einsatz eines Motorschutzkontaktes, für die Primärpumpe, entfernt werden	Wire jumper, must be removed if a motor protection contact is used for the primary pump	Retirer le cavalier à fil si utilisation d'un contact de disjoncteur de moteur, pour la pompe primaire
A4	Drahtbrücke, muss bei Einsatz eines Motorschutzkontaktes, für den Verdichter, entfernt werden Offene Drahtbrücken oder Kontakte bedeuten Sperre oder Störung	Wire jumper, must be removed when a motor protection contact is used for the compressor Open wire jumpers or contacts mean: block or fault	Retirer le cavalier à fil si utilisation d'un contact de disjoncteur de moteur, pour le compresseur Cavaliers à fil ou contacts ouverts signifient coupure ou panne
B2*	Pressostat Niederdruck Sole	Low-pressure brine controller	Pressostat eau glycolée basse pression
B3*	Thermostat Warmwasser	Hot water thermostat	Thermostat eau chaude
B4*	Thermostat Schwimmbadwasser	Swimming pool water thermostat	Thermostat eau de piscine
C1	Betriebskondensator Verdichter	Running capacitor, compressor	Condensateur de service - compresseur
E10*	2. Wärmeerzeuger - Funktion ist über Regler wählbar	2nd heat generator (function selectable via controller)	2e générateur de chaleur (fonction réglable par le régulateur)
F2	Lastsicherung für N1-Relaisausgänge an J12 und J13 4,0 ATr	Load fuse for N1 relay outputs at J12 and J13 4.0 slow-acting	Coupe-circuit de charge pour sorties de relais en J12 et J13 4,0 ATr
F3	Lastsicherung für N1-Relaisausgänge an J15 bis J18 4,0 ATr	Load fuse for N1 relay outputs at J15 to J18 4.0 slow-acting	Coupe-circuit de charge pour sorties de relais en J15 jusqu'à J18 4,0 ATr
F4	Pressostat Hochdruck	High-pressure switch	Pressostat haute pression
F5	Pressostat Niederdruck	Low-pressure switch	Pressostat basse pression
J1...J18	Klemmensteckverbinder an N1	Terminal connector at N1	Connecteur à bornes sur N1
K5	Schütz Primärpumpe (PUP)	Contact for primary pump (PUP)	Contacteur pompe primaire (PUP)
K11*	Elektron. Relais für Störferrnanzeige	Electron. remote fault indicator relay	Relais pour télé-détection de pannes
K12*	Elektron. Relais f. Schwimmbadwasserumwälzpumpe	Electron. relay for swimming pool water circulating pump	Relais pour circulateur d'eau de piscine
K20*	Schütz 2. Wärmeerzeuger (Heizkessel od. elektr. Heizstab)	Contact for 2nd heat generator (boiler or electric heating element)	Contacteur 2e générateur de chaleur (chaudière ou cartouche chauffante électr.)
K21*	Schütz elekt. Tauchheizkörper Warmwasser	Contact, electric immersion heater, hot water	Contacteur thermoplongeur élect. eau chaude
K22*	EVU-Sperrschütz	Utility blocking contactor	Contacteur de coupure du fournisseur d'énergie
K23*	SPR-Hilfsrelay	SPR auxiliary relay	Relais auxiliaire SPR
K25	Startrelais für N7	Starting relay for N7	Relais de démarrage pour N7
M1	Verdichter	Compressor	Compresseur
M11*	Primärpumpe	Primary pump	Pompe primaire
M13*	Heizungsumwälzpumpe	Heat circulating pump	Circulateur de chauffage
M15*	Heizungsumwälzpumpe 2. Heizkreis	Heat circulating pump for heating circuit 2	Circulateur de chauffage pour le 2e circuit de chauffage
M16*	Zusatzumwälzpumpe	Auxiliary circulating pump	Circulateur supplémentaire
M18*	Warmwasserumwälzpumpe	Hot water circulating pump	Circulateur d'eau chaude
M19*	Schwimmbadwasserumwälzpumpe	Swimming pool circulating pump	Circulateur de la piscine
M21*	Mischer Hauptkreis	Mixer, principal circuit	Mélangeur circuit principal
M22*	Mischer 2. Heizkreis	Mixer for heating circuit 2	Mélangeur 2e circuit de chauffage
N1	Wärmepumpenregler	Heat pump controller	Régulateur de pompe à chaleur
N7	Sanftanlaufsteuerung	Soft start control	Commande de démarrage progressif
N11*	Relaisbaugruppe	Relay module	Module de relais
N14	Bedienteil	Operating element	Commande
R1*	Außenfühler	External sensor	Sonde extérieure
R2	Rücklauffühler	Return flow sensor	Sonde de retour
R3*	Warmwasserfühler (alternativ zum Warmwasserthermostat)	Hot water sensor (as an alternative to the hot water thermostat)	Sonde d'eau chaude (alternative au thermostat eau chaude)
R5*	Fühler für 2ten Heizkreis	Sensor for heating circuit 2	Sonde pour 2e circuit de chauffage
R6	Eingefrierschutzfühler	Flow temperature limit sensor	Sonde antigel
R7	Kodierwiderstand 40k2	Coding resistor 40.2 kOhm	Résistance avec code des couleurs 40k2
R9	Vorlauffühler	Flow sensor	Sonde aller
T1	Sicherheitstrenntransformator 230/24V AC-28VA	Safety isolating transformer 230/24 V AC-28 VA	Transformateur sectionneur de sécurité 230/24 V AC-28 V A
X1	Klemmenleiste Netz-Steuerung L/N/PE-230V AC-50 Hz/Sicherungen/N- und PE-Verteiler	Terminal strip mains control L/N/PE-230V AC-50 Hz/fuses/N and PE terminal blocks	Bornier commande réseau L/N/PE-230 V AC-50 Hz/fusibles/distributeur N et PE
X2	Klemmenleiste 24V AC-Verteiler	Terminal strip 24V AC terminal block	Bornier distributeur pour 24 V AC
X3	Klemmenleiste GND-Verteiler für Sensoren	Terminal strip for GND terminal block for sensors	Bornier distributeur GND pour capteurs
X4	Klemmenleiste Verdichter	Terminal strip Compressor	Bornier distributeur Compresseur
X6	Klemmenleiste Leistungseinspeisung L/N/PE-230V AC-50 Hz	Terminal strip for power supply L/N/PE-230V AC-50 Hz	Bornier alimentation puissance L/N/PE-230 V AC-50 Hz
	Abkürzungen:	Abbreviations:	Abbréviations :
EVS	EVU-Sperreingang	Utility disable contactor	Entrée de coupure fournisseur d'énergie
SPR	Zusätzlicher Sperreingang	Supplementary disable contactor	Entrée de « coupure courant » complémentaire
MA	Mischer AUF	Mixer OPEN	Mélangeur OUVERT
MZ	Mischer ZU	Mixer CLOSED	Mélangeur FERME
*	Bauteile sind extern beizustellen	Components to be supplied from external sources	Pièces à fournir par le client
- - - - -	bauseits bei Bedarf anzuschließen	To be connected by the customer as required	à raccorder par le client au besoin
—	werksseitig verdrahtet	Wired ready for use	câblé départ usine

4 Hydraulisches Prinzipschema / Hydraulic Plumbing Diagram / Schéma hydraulique

4.1 Darstellung / Schematic View / Représentation

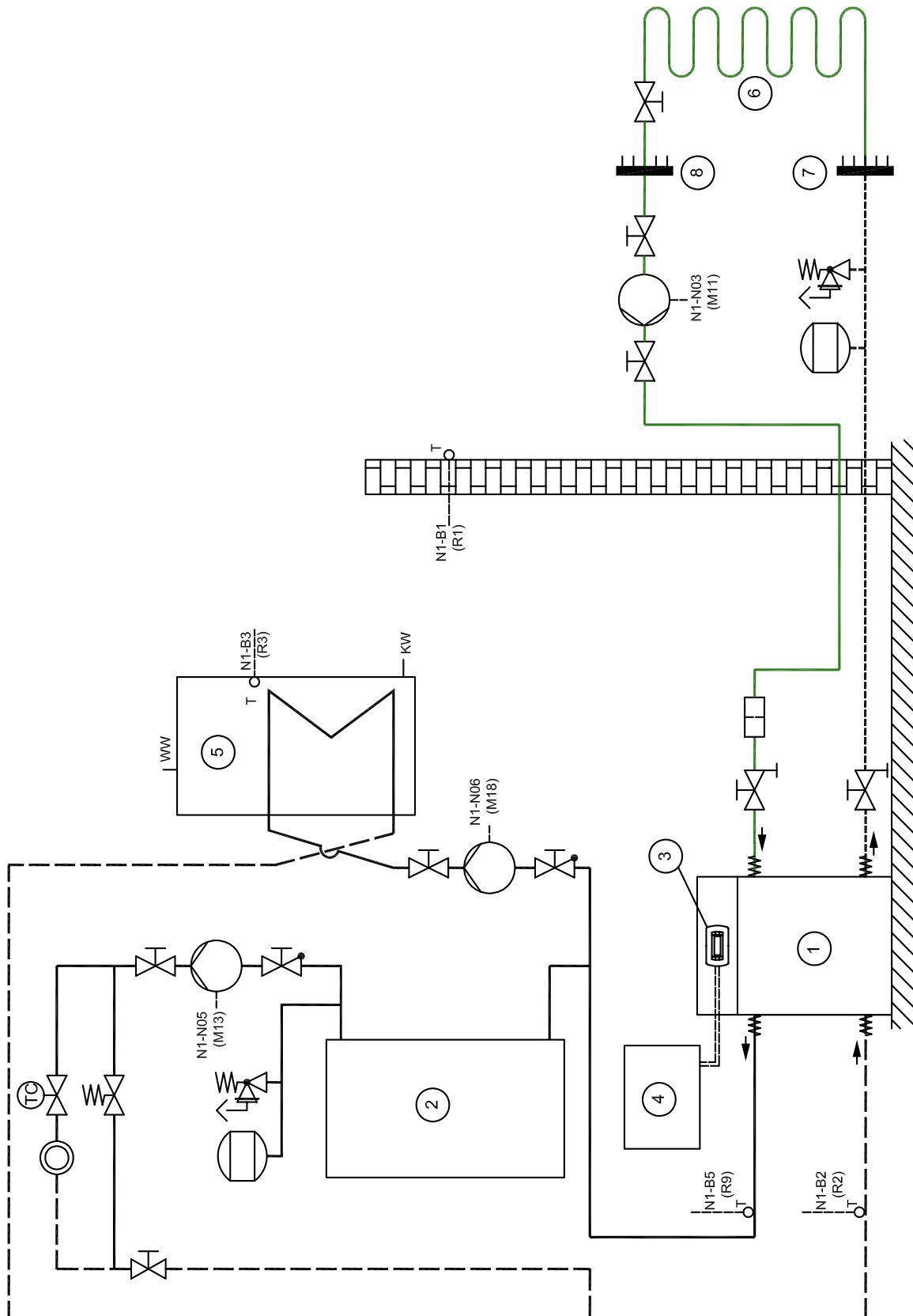

4.2 Legende / Legend / Légende

	Absperrventil	Shutoff valve	Robinet d'arrêt
	Absperrventil mit Entleerung	Shutoff valve with drainage	Robinet d'arrêt avec purge
	Überstromventil	Overflow valve	Vanne de trop-plein
	Sicherheitsventil	Safety valve	Vanne de sécurité
	Umwälzpumpe	Circulating pump	Circulateur
	Ausdehnungsgefäß	Expansion vessel	Vase d'expansion
	Raumtemperaturgesteuertes Ventil	Room temperature-controlled valve	Vanne commandée par température
	Absperrventil mit Rückschlagventil	Shutoff valve with check valve	Robinet d'arrêt avec clapet anti-retour
	Wärmeverbraucher	Heat consumer	Consommateur de chaleur
	Schmutzfänger	Dirt trap	Collecteur d'impuretés
	Temperaturfühler	Temperature sensor	Sonde de température
	Flexibler Anschlusschlauch	Flexible connection hose	Tuyau de raccord flexible
①	Wärmepumpe	Heat pump	Pompe à chaleur
②	Pufferspeicher	Buffer tank	Réservoir tampon
③	Wärmepumpenregler	Heat pump controller	Régulateur de pompe à chaleur
④	Elektroverteilung	Electrical distribution system	Distributeur courant électrique
⑤	Warmwasserspeicher	Hot water cylinder	Réservoir d'eau chaude
⑥	Erdreichkollektoren	Ground heat collectors	Collecteurs géothermiques
⑥	Erdwärmesonden	Borehole heat exchangers	Sondes géothermiques
⑦	Soleverteiler	Brine circuit manifold	Distributeur d'eau glycolée
⑧	Solesammler	Brine collector	Absorbeur à circulation d'eau glycolée
M11	Soleumwälzpumpe	Brine circulating pump	Circulateur d'eau glycolée
M13	Heizungsumwälzpumpe	Heat circulating pump	Circulateur de chauffage
M18	Warmwasserumwälzpumpe	Hot water circulating pump	Circulateur d'eau chaude
R1	Außenwandfühler	External wall sensor	Sonde de paroi extérieure
R2	Rücklauffühler	Return flow sensor	Sonde de retour
R3	Warmwasserfühler	Hot water sensor	Sonde d'eau chaude
R9	Vorlauffühler	Flow sensor	Sonde aller
KW	Kaltwasser	Cold water	Eau froide
WW	Warmwasser	Domestic hot water	Eau chaude

5 Konformitätserklärung / Declaration of Conformity / Déclaration de conformité

EG - Konformitätserklärung EC Declaration of Conformity Déclaration de conformité CE

Der Unterzeichnete
The undersigned
La société soussignée,

Glen Dimplex Deutschland GmbH
Geschäftsbereich Dimplex
Am Goldenen Feld 18
D - 95326 Kulmbach

bestätigt, dass das (die) nachfolgend be-
zeichnete(n) Gerät(e) aufgrund seiner (ihrer)
Konzipierung und Bauart sowie in der von
uns in Verkehr gebrachten Ausführung den
entsprechenden grundlegenden Anforderungen
der EG-Richtlinien entspricht (entsprechen).

Bei einer nicht mit uns abgestimmten
Änderung des (der) Gerät(e)s verliert
diese Erklärung ihre Gültigkeit.

hereby confirm that the design and con-
struction of the product(s) listed below,
in the version(s) placed on the market by
us, conform to the relevant requirements
of the applicable EC directives.

This declaration becomes invalidated
if any modifications are made to
the product(s) without our prior
authorisation.

certifie que l'appareil / les appareils ci-
après, par leur conception et leur mode de
construction ainsi que par la définition
technique avec laquelle il(s) sont mis en
circulation par notre société, est / sont
conforme(s) aux directives fondamentales
CEE afférentes.

Ce certificat perd sa validité pour tout
appareil modifié sans notre consentement.

Bezeichnung / Designation / Désignation

Sole/Wasser-Wärmepumpen
für Innenaufstellung mit R407C

Brine-to-water heat pumps
for indoor installation, containing R407C

Pompes à chaleur eau glycolée/eau
pour installation intérieure avec R407C

EG - Richtlinien / EC Directives / Directives CEE

EG- Niederspannungsrichtlinie / EC Low Voltage Directive /
Directive CEE relative à la basse tension (2006/95/EG)

EG-EMV-Richtlinie / EC EMC Directive / Directive CEE
relative à la compatibilité électromagnétique (89/336/EWG)

Druckgeräterichtlinie / Pressure Equipment Directive /
Directive CEE relative aux appareils sous pression (97/23/EG)

Typ(e):

Harmonisierte EN / Harmonized EB Standards / Normes EN harmonisées:

SI 5ME	EN 255:1997	
SI 7ME	EN 378:2000	
SI 9ME	DIN 8901	
SI 11ME	DIN EN 60335-1 (VDE 0700 T1):2006	EN 60335-1:2002+A11+A1+A12+ Corr.+A2:2006
SI 14ME	DIN EN 60335-2-40 (VDE 0700 T40):2006-11	EN 60335-2-40:2003+A11+A12+A1+Corr.:2006
	DIN EN 55014-1 (VDE 0875 T14-1):2003-09	EN 55014-1:2000+A1:2001+A2:2002
	DIN EN 55014-2 (VDE 0875 T14-2):2002-08	EN 55014-2:1997+A1:2001
	DIN EN 61000-3-2 (VDE 0838 T2):2005-09	EN 61000-3-2:2000+A2:2005
	DIN EN 61000-3-3 (VDE 0838 T3):2002-05	EN 61000-3-3:1995+Corr.:1997+A1:2001

Nationale Richtlinien / National Directives / Directives nationales

D	A	CH
BGR 500		SVTI

Kulmbach, 09.02.2007
CE02W01L.doc

Wolfgang Weinhold
Geschäftsführer / Managing Director

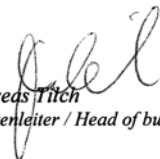
Andreas Titch
Spartenleiter / Head of business unit

